

Designer Radiator Wall Hanging Instructions

PLEASE READ THROUGH THESE INSTALLATION INSTRUCTIONS BEFORE STARTING INSTALLATION

- THIS PRODUCT IS ONLY SUITABLE FOR USE ON INDIRECT OR SEALED CENTRAL HEATING SYSTEMS INCLUDING COMBINATION BOILERS
- THIS RADIATOR MUST BE INSTALLED BY A QUALIFIED PROFESSIONAL OR OTHER FULLY COMPETENT PERSON
- PLEASE CHECK THAT THE RADIATOR IS OF THE CORRECT SIZE AND TYPE BEFORE REMOVING ANY PACKAGING
- DO NOT THROW ANY PACKAGING AWAY UNTIL YOU HAVE LOCATED THE BRACKETS AND FIXING PACK
- WE WOULD RECOMMEND THE USE OF GLOVES AND PROTECTIVE FOOTWEAR WHEN INSTALLING RADIATORS

Tools required

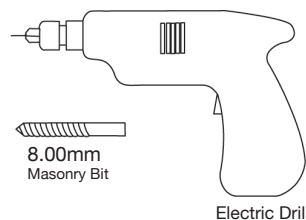
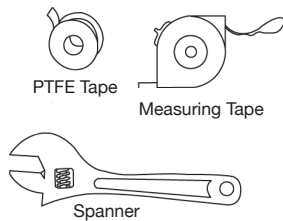
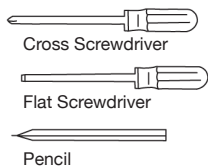

Optional Extra
(available from website)

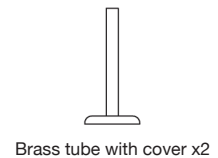

Reference Guide

Contents List

Ref	Icon	Description	QTY
Ref 1		Plug	1
Ref 2		Air Vent	1
Ref 3		Masonry Wall Plug	8
Ref 4		Long Screw	8
Ref 5		Bracket	4
Ref 6		Screw Cap	8
Ref 7		Bracket Cover	8

Fixing kit could be different from product to product.

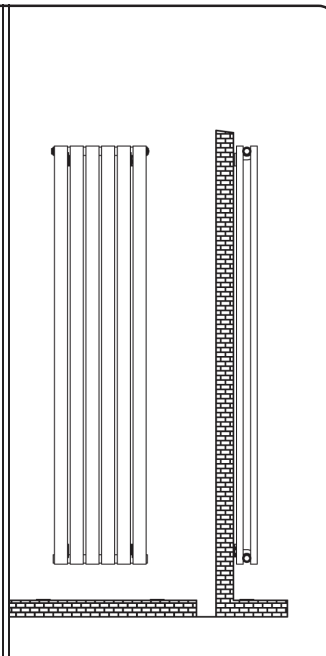

A

Install Plug (Ref 1) and Air Vent (Ref 2) into the correct position (Figure I)

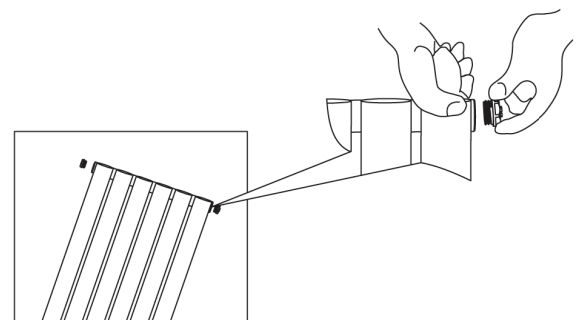

ATTENTION: Do not over-tighten, this may damage the thread.

B

1. Choose an appropriate Position and mark the fixing points with a pencil.
2. Ensure the brackets fit between the columns of the radiator, and are at the correct vertical distance (this will be the same as the distance between the horizontal crossbars)

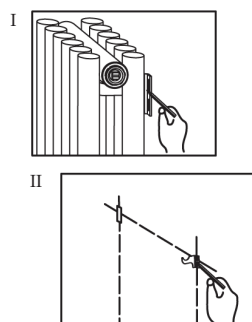
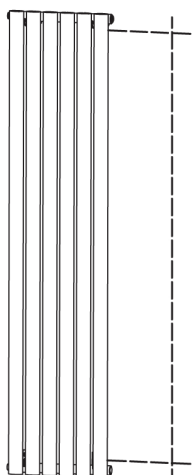

C

1. Drill a hole on the marked place by Ø8mm electric drill. (Figure I)
2. Insert wall plug (Ref 3) into the 8mm hole
3. Place long screw (Ref 4) through the Shim (Ref 6) and Hook (Ref 5), and tighten into Wall Plug (Ref 3)... (Figure III)

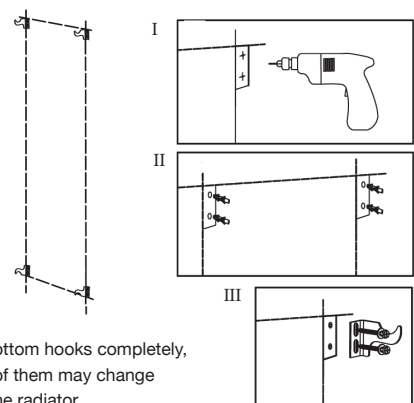

ATTENTION:
Do not fix the bottom hooks completely, as the position of them may change when hanging the radiator

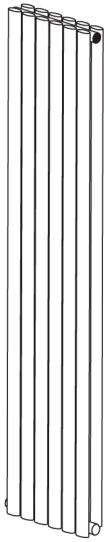
D

1. Fix the radiator onto the top hooks
2. If necessary, adjust the bottom hooks, then fasten to ensure they fix to the radiator securely.

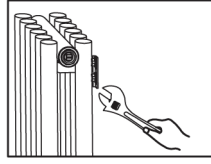
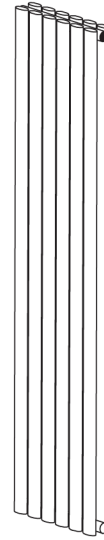
**E**

1. The radiator is now ready to be connected to the hot water central heating system.

This process must be completed by a fully qualified person

RADIATOR CARE

To ensure you can enjoy your radiator for as long as possible, it is essential you first **FLUSH YOUR HEATING SYSTEM WITH A CENTRAL HEATING CLEANSER**, this will clear any waste from the system. Following the cleansing of the system you must **PROTECT THE SYSTEM WITH A CENTRAL HEATING INHIBITOR**. These two simple steps will greatly increase the efficiency and lifespan of your central heating system. Failure to complete these steps increases the chance of pinhole leaks, and will also invalidate the guarantee on your radiator.

Please note...

- This product can only be used at PN ≤ 1MPa (10g/cm², 10 Bar). It should only be filled with water, and at a temperature below 100 °C (212°F). See table below for installation requirements.
- If the temperature exceeds 48 °C (or 120 °F), please show a warning sign near the product to avoid burning and scolding accidents.

Fill ¾ Full	Pressure	Temperature	Comments
Water only	PN ≤ 1Mpa	0° C < t ≤ 100°C	If ambient temperature drops below 1°C, drain out the water to prevent freezing.